





















zu verkaufen

# BMC Trailfox TF01, 29", XTR



	APS (Rear Travel 150mm)
	Carbon
	S / M / L
	Fox 34 Talas CTD Adj FIT Factory Kashima 150mm
	Fox Float Adj CTDFactory Kashima
	2 x 10
	Shimano XTR 38-24
	Shimano XTR 11-36
	Shimano XTR
	Shimano XTR Shadow PLUS
	Shimano XTR I-Spec
	Shimano XTR Trail 203/180mm
	BMC MFB01 Carbon
	Easton Haven
	Rock Shock Reverb Stealth 150mm
	Fizik Tundra 2
	DT Swiss XRC 1350 Spline
	DT Swiss XRC 1350 Spline
	Continental Mountain King / X-King 2.4 Protection
	Brown

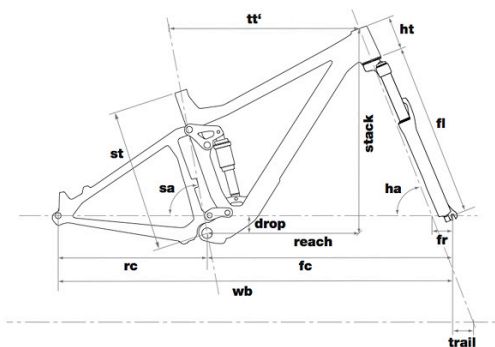

## Geometry TF01

size	rider height	stack	reach	st	tt'	ht	sa	ha	rc	fc	wb	drop	fi	fr	trail	crank length	stem length	bar width
S	166-175	610	410	400	585	90	74	67	435	712	1045	30	562	51	104	170	55	750
M	172-184	615	435	440	611	95	74	67	435	739	1173	30	562	51	104	175	55	750
L	182-195	619	460	480	638	100	74	67	435	766	1200	30	562	51	104	175	55	750

Rahmengröße M, Gewicht 12,28kg, Frontreifen Magic Mary

Kaufdatum Juli 2015

NP: 8.999.- **VK 4500.-**, Privatverkauf

Günther 0664-4378601